

## Medical

	<b>Type SH5241</b> <b>22,8V 50W G6,35-15</b>
	<b>Ordering - No.</b> <b>55241</b>
<b>Product Description</b>	Special Halogen Lamp
<b>Features</b>	Quartz Bulb, Exactly positioned Filament
<b>Applications</b>	Medical, Microscope, Analysis

## Technical Details

Category	HLL
Rated Voltage (V)	22,8
Wattage (W)	max. 55
Luminous Flux (lm)	950 - 15%
Average Lifetime (h)	1000
Base	G6,35-15
Overall Length (mm)	max. 44
Bulb Diameter (mm)	max. 11
Light Center Length (mm)	30 ± 0,5
Operating Position	s90
Packaging Configuration	100 pcs.
Environmental Remark	Product don't contain lead or mercury and is conform with Directive 2002/95/EC "Restriction of the use of certain hazardous substances in electrical and electronic equipment".

## Drawing (in mm)

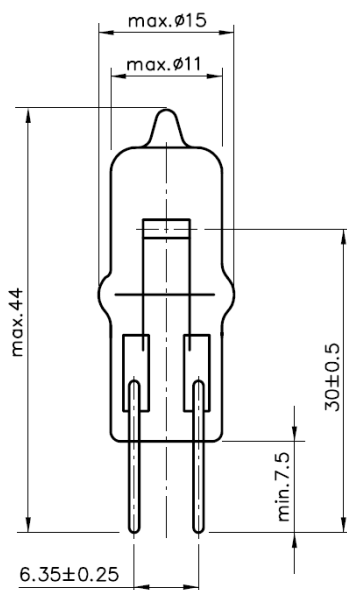

valid from	05.03.2014—V2—PN14/0072
replace for	29.01.2013—V1
file	55241.100.pdf